

■ RS1590

Features 特点

- Susing flat wire, and SMD type. 采用扁平线，贴片类型
- Low radiation noise by magnetically shielded construction
闭合磁路封装，低辐射
- High current, Low resistance. 大电流，低电阻
- Operating temperature : -40°C~+125°C. 工作温度：-40°C~+125°C
- Tape and reel packaging: -40°C to +80°C 卷带包装：-40°C 至 +80°C
- Resistance to soldering heat Max three 40 second reflows at +260°C, parts cooled to room temperature between cycles
耐焊接热 最多三个 40 秒回流 +260°C，部件在循环之间冷却至室温
- Moisture Sensitivity Level (MSL) 1 (unlimited floor life at <30°C / 85% relative humidity)
湿气敏感度等级 (MSL) 1 (在 <30°C 时的无限车间寿命/ 85% 相对湿度)

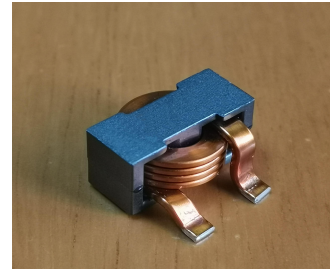

Applications

- high efficiency DC/DC converters. 高效 DC/DC 转换器
- Single and polyphase buck converters. 单相、多相降压转换器
- Filter for audio applications. 音频滤波应用
- Optimized for high current boost applications. 大电流升压应用优化

Electrical characteristics

Part number 料号	Inductance 电感量 μH±20%	DCR 直流电阻 mΩ		SRF 自谐频率 MHz		Isat 饱和电流 A typical				Irms 温升电流 A typical 40°C rise
		Typ	Max	typical	10% drop	20% drop	30% drop			
RS1590-R30M	0.3	0.66	0.75	260	53	56	57	32		
RS1590-R30M	0.5	0.87	0.94	202	39	43	44	27		
RS1590-R60M	0.6	0.87	0.94	182	33	35	36	27		
RS1590-R68M	0.68	0.87	0.94	165	30	32	33	27		
RS1590-R80M	0.8	0.87	0.94	123	25	26	27	27		
RS1590-R90M	0.9	1.05	1.15	160	27	28	29	22		
RS1590-1R0M	1.0	0.87	0.94	115	20	22	23	27		
RS1590-1R2M	1.2	1.05	1.15	90	20	22	23	22		
RS1590-1R5M	1.5	1.05	1.15	73	17	18	19	22		

Remark

- ① Inductance is measured with a LCR meter Agilent 4284A or equivalent.
Test frequency at 100kHz
- ② DC resistance is measured with Keithley 580 Milliohm Meter, or equivalent.
Reference ambient temperature 25°C
- ③ SRF measured using an Agilent 4395A network analyzer and an Agilent 16193A test fixture.
- ④ DC current at 25°C that causes the specified inductance drop from its value without current.
- ⑤ Current that causes the specified temperature rise from 25°C ambient. This information is for reference only and does not represent absolute maximum ratings.
- ⑥ Electrical specifications at 25°C

备注

- ① 电感量测试采用 Agilent 4284A 数字电桥或同等仪器；
测试频率 100KHz
- ② 直流电阻测试采用 Keithley 580 毫欧表或同等仪器；
环境温度 25°C
- ③ SRF 使用 Agilent 4395A 网络分析仪和 Agilent 16193A 测试夹具测量。
- ④ 直流电流在 25°C，加载导致指定电感从没有电流的值下降。
- ⑤ 导致指定温度从 25°C 环境温度上升的电流。此信息仅供参考，不代表绝对最大额定值。
- ⑥ 25°C 时的电气规格

Dimensions 结构尺寸

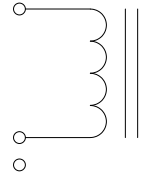
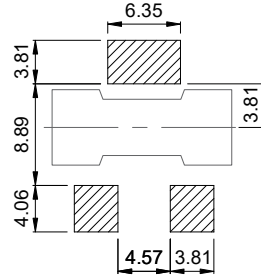
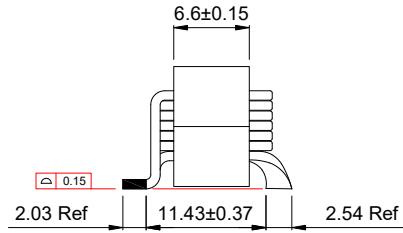
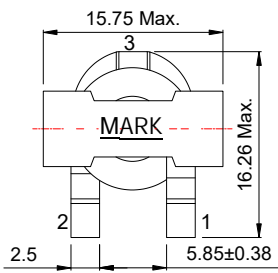

Terminal 3 is provided for mounting stability only. This terminal is connected to the winding of the inductor and must not be connected to ground or any circuitry.

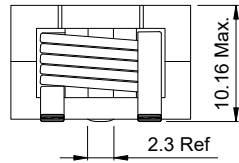

Electrical Characteristic Curve

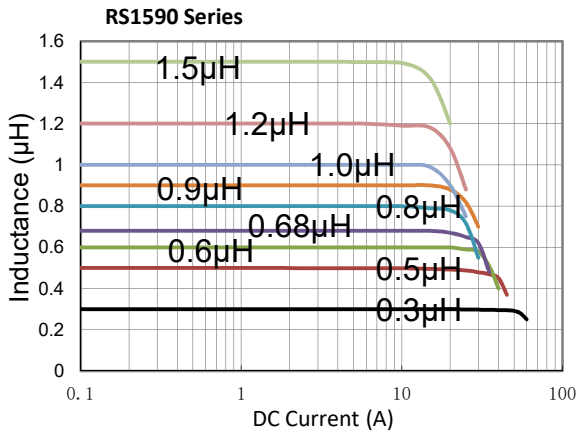

■ Packaging Specification - Tape and Reel: [mm]

包装规格 - 卷带包装: [mm]

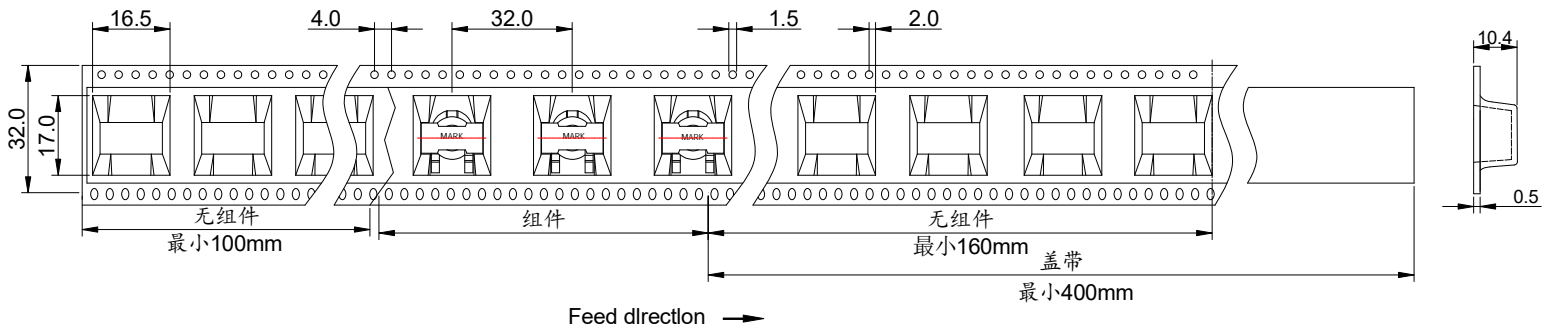
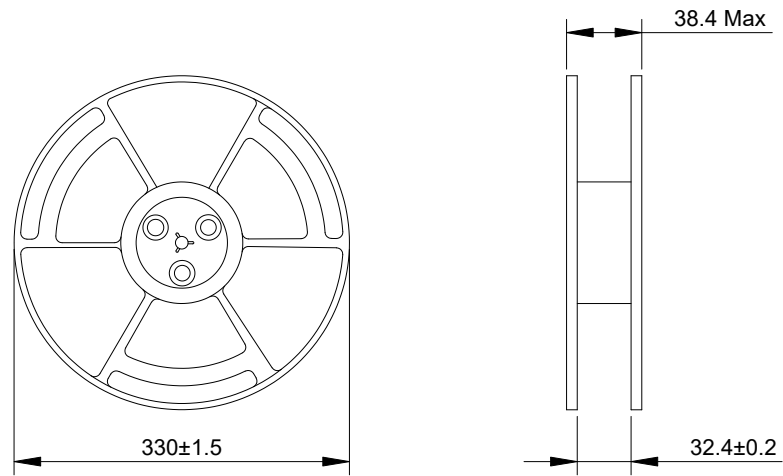

Weight 重量: 4.12-5.15g/PCS

Packaging 包装数量: 250 PCS/Reel